



# SPECTRUM

SYSTEMENTWICKLUNG MICROELECTRONIC GMBH

## M3i.41xx - 14 bit transient recorder up to 400 MS/s

- Up to 400 MS/s on one channel or 250 MS/s on two channels
- Simultaneously sampling on all channels
- Separate monolithic ADC and amplifier per channel
- 6 input ranges:  $\pm 200$  mV up to  $\pm 10$  V
- Up to 2 synchronous digital channels with multi-purpose I/O
- Up to 2 GSample (4 GByte) on-board memory
- 128 MSample standard memory installed
- Window, re-arm, OR/AND trigger
- Synchronization of up to 8 cards per system
- Options: Multiple Recording, Timestamps

Speed	SNR	ENOB
100 MS/s	up to 67.7 dB	up to 11.0 LSB
250 MS/s	up to 67.7 dB	up to 11.0 LSB
400 MS/s	up to 65.6 dB	up to 10.6 LSB



- 66 MHz 32 bit PCI-X interface
- 5V / 3.3V PCI compatible
- 100% compatible to conventional PCI > V2.1
- Sustained streaming mode up to 245 MB/s

- 2,5 GBit x1 PCIe Interface
- Works with x1/x4/x8/x16\* PCIe slots
- Software compatible to PCI
- Sustained streaming mode up to 160 MB/s

<u>Operating Systems</u>	<u>Recommended Software</u>	<u>Drivers</u>
<ul style="list-style-type: none"> <li>• Windows 2k, XP, Vista, 7</li> <li>• Linux Kernel 2.4 + 2.6</li> <li>• Windows/Linux 32 and 64 bit</li> </ul>	<ul style="list-style-type: none"> <li>• Visual Basic, Visual C++, Borland C++ Builder, GNU C++, Borland Delphi, VB.NET, C#, J#</li> <li>• SBench 6</li> </ul>	<ul style="list-style-type: none"> <li>• MATLAB</li> <li>• LabVIEW</li> <li>• LabWindows/CVI</li> <li>• Agilent VEE</li> </ul>

Model	1 channel	2 channels
M3i.4110	100 MS/s	
M3i.4111	100 MS/s	100 MS/s
M3i.4120	250 MS/s	
M3i.4121	250 MS/s	250 MS/s
M3i.4140	400 MS/s	
M3i.4142	400 MS/s	250 MS/s

### General Information

The 6 models of the M3i.41xx series are designed for the fast and high quality data acquisition. Each of the input channels has its own monolithic A/D converter and its own programmable input amplifier. This allows to record signals simultaneously on both channels with 14 bit resolution without any phase delay between them. The extremely large on-board memory allows long time recording even with the highest sampling rates. All boards of the M3i.41xx series may use the whole installed on-board memory for the currently activated number of channels. A FIFO mode is also integrated on the board. This allows the acquisition of data continuously for online processing or for data storage to hard disk.

\*Some x16 PCIe slots are for the use of graphic cards only and can not be used for other cards.

## Software Support

### Windows drivers

The cards are delivered with drivers for Windows 2000, XP, XP64, Vista and Vista64 as well as Windows 7. Programming examples for Visual C++, Borland C++ Builder, LabWindows/CVI, Borland Delphi, Visual Basic, VB.NET, C# and J# are included.

### Linux Drivers



All cards are delivered with full Linux support. Pre compiled kernel modules are included for the most common distributions like RedHat, Fedora, Suse or Debian. The Linux support includes SMP systems, 32 bit and 64 bit systems, versatile programming examples for Gnu C++ as well as the possibility to get the driver sources for own compilation.

### SBench 6

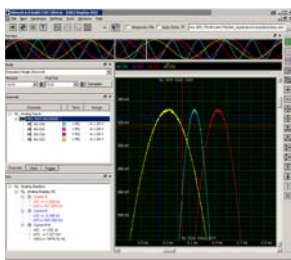

A base licence of SBench 6 the easy-to-use graphical operating software for the Spectrum cards is included in the delivery. Using the base license it is possible to test the card and to show acquired data. There are also some basic measurement functions included in the base license. The card comes with a demo license for the professional

version giving the user the opportunity to test the features of the professional version with the new hardware. Existing customers have the opportunity to request a demo license for the professional version at Spectrum. The professional version contains several new measurement functions, FFT, import and export (including MATLAB and ASCII) as well as the streaming modes. The data streaming modes allow to continuously acquire data to hard disk. SBench 6 has been optimized to handle data files of several GByte. More details on SBench 6 are found in the dedicated SBench 6 data sheet. The version 6 is running under Windows as well as under Linux (KDE and GNOME). A test version of SBench 6 is freely available in the internet. This test version will also operate with demo cards and can be tested as Professional version without any hardware installed.

### Third-party products

A lot of third-party products are supported as an option. Choose between LabVIEW, MATLAB and Agilent VEE. All drivers come with examples and detailed documentation.

## Hardware features and options

### PCI/PCI-X



The cards with PCI/PCI-X bus connector use 32 Bit and up to 66 MHz clock rate for data transfer. They are 100% compatible to Conventional PCI > V2.1. The universal interface allows the use in PCI slots with 5 V I/O and 3.3 V I/O voltages as well as in PCI-

X or PCI 64 slots. The maximum sustained data transfer rate is 245 MByte/s per bus segment.

### PCI Express



The cards with PCI Express use a x1 PCIe connector. They can be used in PCI Express x1/x4/x8/x16 slots, except special graphic card slots, and are 100% software compatible to

Conventional PCI > V2.1. The maximum sustained data transfer rate is 160 MByte/s per slot.

### Input Amplifier

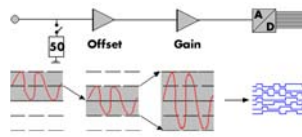

The analog inputs can be adapted to real world signals using a wide variety of settings that are individual for each channel. By using software commands the input termination can be changed

between 50 Ohm and 1 MOhm, one can select a matching input range and the signal offset can be compensated by programmable AC coupling.

### Software selectable input path

For each of the analog channels the user has the choice between two analog input paths. The „Buffered“ path offers the highest flexibility when it comes to input ranges and termination. A software programmable 50 Ohm and 1 MOhm termination also allows to connect standard oscilloscope probes to the card. The „50 Ohm“ path on the other hand provides the highest bandwidth and the best signal integrity with a fewer number of input ranges and a fixed 50 Ohm termination.

### Software selectable lowpass filter

Each analog channel contains a software selectable low-pass filter to limit the input bandwidth. Reducing the analog input bandwidth results in a lower total noise and can be useful especially with low voltage input signals.

### Automatic on-board calibration

All of the channels are calibrated in factory before the board is shipped. To compensate for different variations like PC power supply, temperature and aging, the software driver provides routines for an automatic onboard offset and gain calibration of all input ranges of the „Buffered“ path. All the cards contain a high precision on-board calibration reference.

### Digital inputs

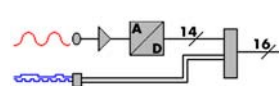

This option acquires additional synchronous digital channels phase-stable with the analog data. A maximum of 2 additional digital inputs are available on the front plate of the card using the multi-purpose I/O lines.

### Ring buffer mode

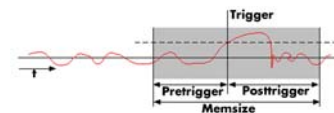

The ring buffer mode is the standard mode of all oscilloscope boards. Data is written in a ring memory of the board until a trigger event is

detected. After the event the posttrigger values are recorded. Because of this continuously recording into a ring buffer there are also samples prior to the trigger event visible: Pretrigger = Memsize - Posttrigger.

### FIFO mode

The FIFO mode is designed for continuous data transfer between measurement board and PC memory (up to 245 MB/s on a PCI-X slot, up to 125 MB/s on a PCI slot and up to 160 MB/s on a PCIe slot) or hard disk. The control of the data stream is done automatically by the driver on interrupt request. The complete installed on-board memory is used for buffer data, making the continuous streaming extremely reliable.

### Channel trigger

The data acquisition boards offer a wide variety of trigger modes. Besides the standard signal checking for level and edge as known

from oscilloscopes it's also possible to define a window trigger. All trigger modes can be combined with a re-arming mode (for accurate trigger recognition on noisy signals) the AND/OR conjunction of different trigger events is possible.

**External trigger input**

All boards can be triggered using an external analog or digital signal. It's possible to use positive or negative edge. As two analog comparators are used, one can also define a window trigger, a hysteresis trigger or a re-arm trigger.

**Universal Multi-Purpose I/Os**



All M3i cards offer two universal multi-purpose I/O lines, which can be separately programmed as either input or output. These lines can be used as additional TTL trigger inputs for more complex trigger conditions. Additionally these lines can also be used to acquire digital data synchronously with the analog data (see Digital Inputs). When used as outputs, these lines can be used to output card status signals like trigger-armed or to output the trigger to synchronize external equipment.

**Multiple Recording**

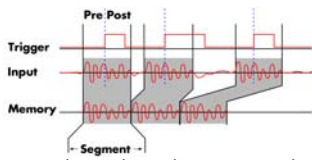

The Multiple Recording option allows the recording of several trigger events with an extremely short re-arming time. The hardware doesn't need to be restarted in between.

The on-board memory is divided in several segments of the same size. Each of them is filled with data if a trigger event occurs. Pre- and posttrigger of the segments can be programmed. The number of acquired segments is only limited by the used memory and is unlimited when using FIFO mode.

**ABA mode**

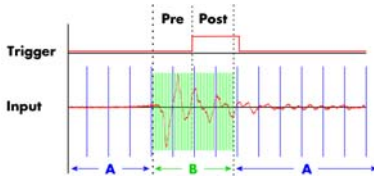

The optional ABA mode combines slow continuous data recording with fast acquisition on trigger events. The ABA mode works like a slow data logger combined with a fast digitizer. The

exact position of the trigger events is stored as timestamps in an extra memory.

**Timestamp**

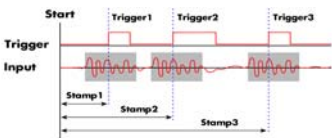

The timestamp option writes the time positions of the trigger events in an extra memory. The timestamps are relative to the start of recording, a defined zero time, externally synchronised to a radio clock, or a GPS receiver. With this

option acquisitions of systems on different locations can be set in a precise time relation.

**External clock input and output**

Using a dedicated connector a sampling clock can be fed in from an external system. Additionally it's also possible to output the internally used sampling clock on a separate connector to synchronize external equipment to this clock.

**Reference clock**

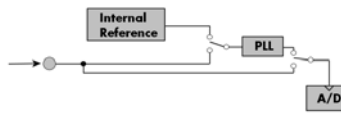

The option to use a precise external reference clock (normally 10 MHz) is necessary to synchronize the board for high-quality measurements with external equipment (like a signal source). It's also possible to enhance the quality of the sampling clock in this way. The driver automatically generates the requested sampling clock from the fed in reference clock.

**Star-Hub**



The star-hub is an additional module allowing the phase stable synchronisation of up to 8 boards of a kind in one system. Independent of the number of boards there is no phase delay between all channels. The star-hub distributes trigger and clock information between all boards. As a result all connected boards are running with the same clock and the same trigger. All trigger sources can be combined with a logical OR allowing all channels of all cards to be trigger source at the same time.

**BaseXIO (enhanced timestamps)**



The BaseXIO option offers 8 asynchronous digital I/O lines on the base card, which are available on a separate bracket as SMB connectors. The direction can be selected by software in groups of four.

In addition one of the I/O lines can be used as reference clock for the Timestamp counter.

## Technical Data

### Analog Inputs

Resolution	14 bit
Differential non linearity (DNL)	≤ 1.5 LSB (ADC, $f_{in} = 70$ MHz)
Integral non linearity (INL)	≤ 3 LSB (ADC, $f_{in} = 70$ MHz)
Programmable input offset	not available
Connector (analog inputs)	3 mm SMB male
Crosstalk sine signal ±1V @ 1 MOhm	1 MHz: <-100dB, 20 MHz <-95 dB
Crosstalk sine signal ±5V @ 1 MOhm	1 MHz: <-77 dB, 20 MHz <-73 dB
Crosstalk sine signal ±5V @ 50 Ohm	1 MHz: <-100dB, 20 MHz <-100 dB
20 MHz BW Filter Characteristics	3rd order Butterworth

### Input Path

	50 ohm path 1	Buffered path 0
Input impedance	fixed 50 Ohm	50 Ohm, 1 MOhm    25 pF
Max input @ 50 Ohm (> ±1 V range)	6 Vrms	5 Vrms
Max input @ 50 Ohm (≤ ±1 V range)	2 Vrms	5 Vrms
Max input @ 1 MOhm (> ±1 V range)	n.a.	±30 V
Max input @ 1 MOhm (≤ ±1 V range)	n.a.	±5 V
Max DC voltage if AC coupling active	±30 V DC level	±30 V DC level
Relative input stage delay	0 ns	3.8 ns
Input ranges	±500 mV, ±1 V, ±2.5 V, ±5 V	±200 mV, ±500 mV, ±1 V, ±2 V, ±5 V, ±10 V
Offset Error after warm-up + calibration	≤0.1% of range	≤0.1% of range
Gain Error after warm-up + calibration	≤1.0% of range	≤0.1% of range

### Trigger

Multiple Recording: re-arming time	≤ 32 Samples
Max Pretrigger at standard mode	up to full memsize
Max Pretrigger at Multi and FIFO	8192 Samples as sum of all active channels
Internal trigger accuracy	1 Sample
Channel trigger resolution	10 bits
Trigger output delay	134 sampling clock cycles (after trigger input)
External trigger type (Ext0)	Analog window comparator
Programmable trigger levels (Ext0)	2 levels +/- 5V in steps of 1 mV
Ext. trigger connector (Ext0)	MMCX female
Ext. trigger max voltage 1 MOhm (Ext0)	±30 V
Ext. trigger max voltage 50 Ohm (Ext0)	5V rms
Ext. trigger impedance (Ext0)	50 Ohm / 1 MOhm    25 pF
External trigger accuracy (All)	1 Sample
Trigger output	see multi purpose I/O lines below

### Power consumption (max speed)

	PCI / PCI-X		PCI EXPRESS	
	3,3 V	5 V	3,3 V	12 V
M3i.41x0 (128 MS memory)	5.0 A	0.1 A	0.4 A	1.4 A
M3i.41x1 (128 MS memory)	6.5 A	0.1 A	0.4 A	1.8 A
M3i.41x2 (128 MS memory)	6.5 A	0.1 A	0.4 A	1.9 A
M3i.41x2 (2 GS memory), max. power	7.4 A	0.1 A	0.4 A	2.6 A

### Max channels with Star-Hub

	SH4	SH8
M3i.41x0	4	8
M3i.41x1	8	16

### BaseXIO (Option)

BaseXIO Connector (extra bracket)	8 x SMB male (8 x MMCX female internal)
BaseXIO input	TTL compatible: Low ≤ 0.8 V, High ≥ 2.0 V
BaseXIO input maximum voltage	-0.5 V up to +5.5 V
BaseXIO output levels	TTL compatible: Low ≤ 0.4 V, High ≥ 2.4 V
BaseXIO output drive strength	32 mA maximum current

### Multi purpose digital I/O

No of multi purpose lines	two
Connector Type	MMCX female
Input: available input signals	Additional TTL trigger, digital input, async input
Input: input impedance	10 k against 3.3 V
Input: digital-in delay to analog sample	0 Samples (>250 MS/s: -3 samples)
Input: maximum voltage	-0.3 V up to +5.5 V
Input: input voltage level	Low ≤ 0.8 V, High ≥ 2.0 V
Output: available output signals	trigger, overrange, arm, run, async output
Output: output impedance	50 Ohm
Output: output levels	Low ≤ 0.4 V, High ≥ 2.4 V
Output: output type	TTL compatible for high-impedance loads
Output: output drive strength	Capable of driving 50 Ohm load

### Option SMA connectors

Available signals for SMA XA	One of Trig-In, Trig-Out, Multi Purpose X0
Available signals for SMA XB	One of Clk-In, Clk-Out, Trig-In

### Clock

Internal clock range	10 MHz to max (see table below)
Internal clock accuracy	max. ± 32 ppm
Internal clock setup granularity	1 Hz
Clock range gaps (internal and external)	70 to 72, 140 to 144, 281 to 287 MHz
External clock input connector/coupling	MMCX female, AC coupled
External clock input termination	50 Ohm fixed
Reference clock: external clock range	≥ 10.0 MHz and ≤ 1.0 GHz
Sampling clock from ref clock range	10 MHz to max (see table below)
Sampling clock from ref clock granularity	1 kHz
External clock delay to internal ADC clock	3.7 ns (8.2 ns at synchronized cards)
External clock input type	single-ended, 3.3V LVPECL
External clock min input swing	0.3 V peak peak
External clock maximum voltage	3.0 V peak peak
External clock duty cycle requirement	40% to 60%
External clock output connector/coupling	MMCX female, AC coupled
External clock output type	single-ended, 3.3V LVPECL
External clock output drive strength	Capable of driving 50 ohm load

### Environmental and Physical details

Dimension (PCB only)	312 mm x 107 mm (full PCI length)
Width (Standard or star-hub 4)	1 full size slot
Width (star-hub 8)	2 full size slots
Width (with BaseXIO)	1 full size slots + 1 half size slot
Weight (plain card)	320 g
Weight (plain card + option SH4)	380 g
Weight (plain card + option SH8)	400 g
Warm up time	10 minutes
Operating temperature	0°C - 50°C
Storage temperature	-10°C - 70°C
Humidity	10% to 90%

### PCI / PCI-X specific details

PCI / PCI-X bus slot type	32 bit 33/66 MHz
PCI / PCI-X bus slot compatibility	32/64 bit, 33-133 MHz, 3,3 and 5 V I/O

### PCI EXPRESS specific details

PCIe slot type	x1
PCIe slot compatibility	x1/x4/x8/x16*

\*Some x16 PCIe slots are for graphic cards only and can not be used for other cards.

### Software programmable parameters

Input Ranges (Buffered path)	±200mV, ±500mV, ±1V, ±2V, ±5V, ±10V
Input Ranges (50 Ohm path)	±500mV, ±1V, ±2.5V, ±5V
Analog input impedance	50 Ohm / 1M Ohm (Buffered path)
Analog input coupling	AC / DC
Analog bandwidth limit filter	on/off
Clock mode	Internal, external reference clock, sync
Trigger mode	Ch0, Ch1, Ext0(Analog), Ext1/2(TTL), SW
Enhanced trigger	Window, Re-Arm, Or/And, Delay
Trigger level (channel)	10 bit resolution realting to input range
Trigger level (Ext0)	1 mV resolution: -5000 mV to +5000 mV
Trigger edge (channel + external)	Rising edge, falling edge or both edges
Trigger delay	0 to 32G samples in steps of 8 samples
External trigger (Ext0) coupling	AC/DC
External trigger (Ext0) impedance	50 Ohm / 1M Ohm
Memory depth	16 up to [installed memory / number of active channels] in steps of 8
Posttrigger	8 up to 4 GSamples in steps of 8
Multiple Recording segment size	16 up to [installed memory / 2 / active channels] in steps of 16
Multiple Recording pretrigger	8 up to [8k samples / number of active channels]

### Certifications, Compliances, Warranty

EMC Immunity	Compliant with CE Mark
EMC Emission	Compliant with CE Mark
Product warranty	2 years starting with the day of delivery
Software and firmware updates	Life-time, free of charge

	M3i.4110	M3i.4111	M3i.4120	M3i.4121	M3i.4140	M3i.4142
max internal clock (1 channel active)	100 MS/s	100 MS/s	250 MS/s	250 MS/s	400 MS/s	400 MS/s
max internal clock (2 channels active)	n.a.	100 MS/s	n.a.	250 MS/s	n.a.	250 MS/s
lower bandwidth limit (DC coupling)	0 Hz	0 Hz	0 Hz	0 Hz	0 Hz	0 Hz
lower bandwidth limit (AC coupled, 50 Ohm)	<30 kHz	<30 kHz	<30 kHz	<30 kHz	<30 kHz	<30 kHz
lower bandwidth limit (AC coupled, 1 MOhm)	<2 Hz	<2 Hz	<2 Hz	<2 Hz	<2 Hz	<2 Hz
-3 dB bandwidth (buffered path)	50 MHz	50 MHz	90 MHz	90 MHz	125 MHz	125 MHz
-3 dB bandwidth (50 ohm path)	50 MHz	50 MHz	125 MHz	125 MHz	200 MHz	200 MHz
-3 dB bandwidth (BW limit enabled)	20 MHz	20 MHz	20 MHz	20 MHz	20 MHz	20 MHz

## Dynamic Parameters

M3i.4142 and M3i.4140, 1 channel 400 MS/s												
Input Path	HF path, AC coupled, fixed 50 Ohm						Buffered path, BW limit			Buffered path, full BW		
Test signal frequency	9 MHz			40 MHz	70 MHz	9 MHz			9 MHz	40 MHz	70 MHz	
Input Range	±500mV	±1V	±2.5V	±5V	±1V	±1V	±200mV	±500mV	±1V	±1V	±1V	±1V
RMS Noise (zero level)	< 3.3 LSB						< 3.5 LSB			< 6.3 LSB		
THD (typ) (dB)	-80.9	-81.1	-79.9	-75.9	-76.1	-64.9	-72.1	-75.0	-71.1	-65.3	-55.5	-51.7
SNR (typ) (dB)	65.0	65.6	65.1	65.6	65.6	65.4	65.7	66.0	66.5	64.0	62.3	61.9
SFDR (typ), excl. harm. (dB)	82.1	84.3	82.3	84.2	82.7	76.5	82.2	80.1	82.3	81.6	77.9	74.3
SFDR (typ), incl. harm. (dB)	82.0	84.3	81.7	77.1	78.1	65.8	75.1	78.0	73.1	66.5	58.8	54.8
SINAD/THD+N (typ) (dB)	64.9	65.5	65.0	65.3	65.3	62.4	64.9	65.8	65.5	61.7	54.9	51.5
ENOB based on SINAD (bit)	10.5	10.6	10.5	10.6	10.6	10.1	10.5	10.6	10.6	10.0	8.8	8.3
ENOB based on SNR (bit)	10.5	10.6	10.6	10.6	10.6	10.6	10.6	10.6	10.7	10.4	10.1	10.0

M3i.4121 and M3i.4120, 1 or 2 channels 250 MS/s												
Input Path	HF path, AC coupled, fixed 50 Ohm						Buffered path, BW limit			Buffered path, full BW		
Test signal frequency	9 MHz			40 MHz	70 MHz	9 MHz			9 MHz	40 MHz	70 MHz	
Input Range	±500mV	±1V	±2.5V	±5V	±1V	±1V	±200mV	±500mV	±1V	±1V	±1V	±1V
RMS Noise (zero level)	< 2.2 LSB						< 2.5 LSB			< 3.4 LSB		
THD (typ) (dB)	-81.2	-80.2	-76.1	-74.0	-82.8	-73.9	-69.5	-75.1	-71.1	-66.0	-57.0	-53.4
SNR (typ) (dB)	67.5	67.7	67.2	67.6	67.7	67.4	67.1	67.6	67.8	66.7	66.6	66.6
SFDR (typ), excl. harm. (dB)	84.3	83.8	83.6	83.7	83.6	74.5	87.4	87.4	87.1	81.0	80.7	79.8
SFDR (typ), incl. harm. (dB)	84.2	83.0	77.5	74.5	83.5	74.4	70.1	76.5	74.2	67.1	59.6	54.3
SINAD/THD+N (typ) (dB)	67.3	67.4	66.7	66.7	67.6	66.6	65.1	66.9	66.3	63.4	56.6	53.2
ENOB based on SINAD (bit)	10.9	10.9	10.8	10.8	10.9	10.8	10.6	10.8	10.7	10.3	9.1	8.6
ENOB based on SNR (bit)	10.9	11.0	10.9	10.9	11.0	10.9	10.9	11.0	11.0	10.8	10.8	10.8

M3i.4111 and M3i.4110, 1 or 2 channels 100 MS/s												
Input Path	HF path, AC coupled, fixed 50 Ohm						Buffered path, BW limit			Buffered path, full BW		
Test signal frequency	9 MHz			40 MHz	70 MHz	9 MHz			9 MHz	40 MHz	70 MHz	
Input Range	±500mV	±1V	±2.5V	±5V	±1V	±1V	±200mV	±500mV	±1V	±1V	±1V	±1V
RMS Noise (zero level)	< 2.2 LSB						< 2.5 LSB			< 3.0 LSB		
THD (typ) (dB)	-80.0	-78.6	-77.5	-76.9	n.a.	n.a.	-67.8	-73.5	-69.5	-66.5	n.a.	n.a.
SNR (typ) (dB)	67.6	67.7	67.4	67.6	n.a.	n.a.	66.5	67.3	67.0	66.9	n.a.	n.a.
SFDR (typ), excl. harm. (dB)	84.5	84.2	84.0	84.4	n.a.	n.a.	84.3	84.4	84.3	84.7	n.a.	n.a.
SFDR (typ), incl. harm. (dB)	83.6	82.0	82.8	80.6	n.a.	n.a.	68.0	76.3	72.1	67.2	n.a.	n.a.
SINAD/THD+N (typ) (dB)	67.3	67.3	66.9	66.9	n.a.	n.a.	64.0	66.4	64.9	63.3	n.a.	n.a.
ENOB based on SINAD (bit)	10.9	10.9	10.9	10.8	n.a.	n.a.	10.3	10.7	10.5	10.2	n.a.	n.a.
ENOB based on SNR (bit)	10.9	11.0	10.9	10.8	n.a.	n.a.	10.7	10.9	10.9	10.8	n.a.	n.a.

A pure sine wave with > 99% amplitude of input range is measured with 50 ohms termination. SNR and RMS noise parameters may differ depending on the quality of the used PC. SNR = Signal to Noise Ratio, THD = Total Harmonic Distortion, SFDR = Spurious Free Dynamic Range, SINAD = Signal Noise and Distortion, ENOB = Effective Number of Bits. For a detailed description please see application note 002.

# Hardware block diagram

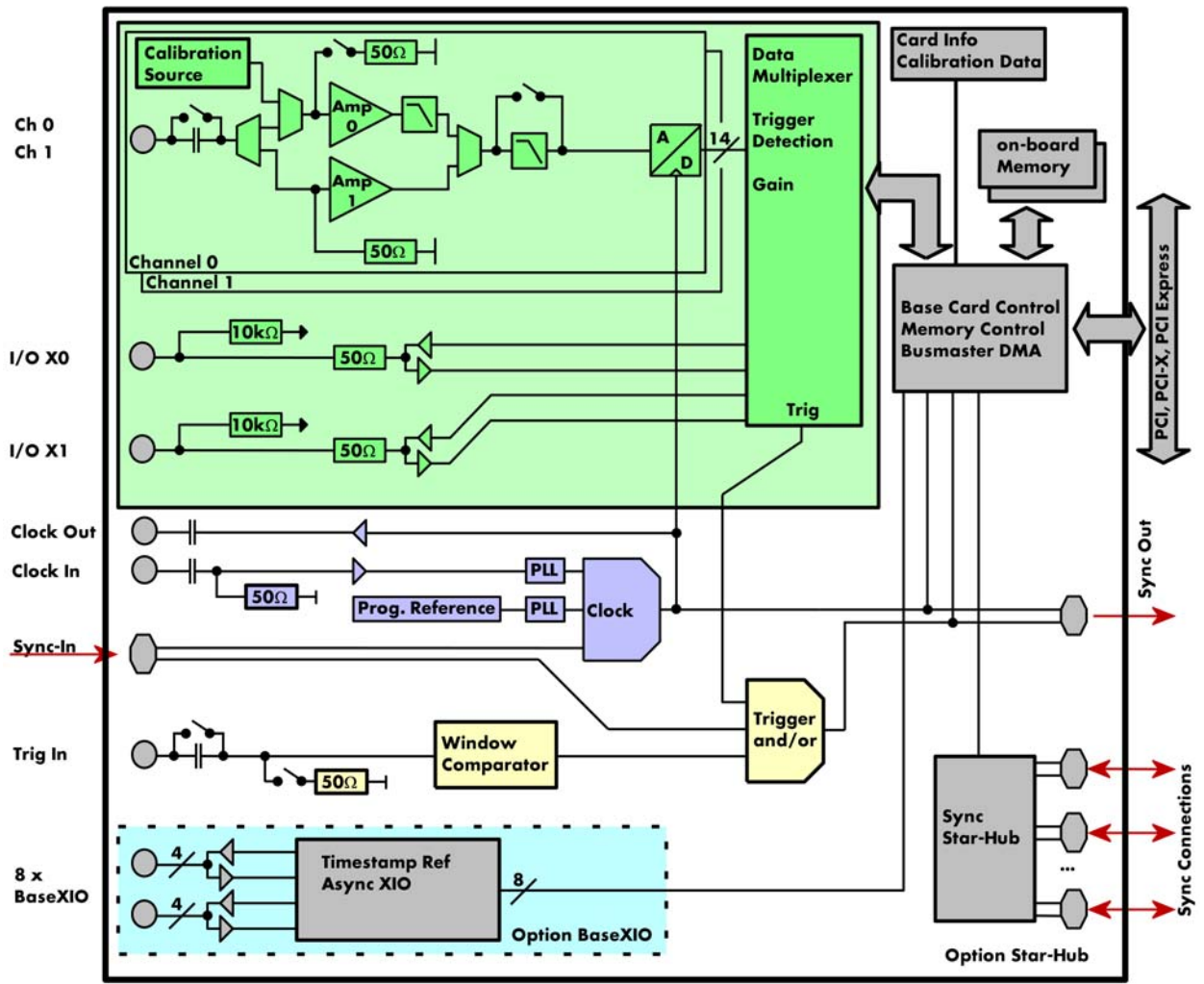

## Order Information

<b>PCI/PCI-X</b>	Order no.	Standard mem	1 channel	2 channels
	M3i.4110	128 MSample	100 MS/s	
	M3i.4111	128 MSample	100 MS/s	100 MS/s
	M3i.4120	128 MSample	250 MS/s	
	M3i.4121	128 MSample	250 MS/s	250 MS/s
	M3i.4140	128 MSample	400 MS/s	
	M3i.4142	128 MSample	400 MS/s	250 MS/s
<b>PCI Express</b>	Order no.	Standard mem	1 channel	2 channels
	M3i.4110-exp	128 MSample	100 MS/s	
	M3i.4111-exp	128 MSample	100 MS/s	100 MS/s
	M3i.4120-exp	128 MSample	250 MS/s	
	M3i.4121-exp	128 MSample	250 MS/s	250 MS/s
	M3i.4140-exp	128 MSample	400 MS/s	
	M3i.4142-exp	128 MSample	400 MS/s	250 MS/s
<b>Memory</b>	Order no.	Option		
	M3i.xxxx-256MS	Memory upgrade to 256 MSample (512 MB) total memory		
	M3i.xxxx-512MS	Memory upgrade to 512 MSample (1 GB) total memory		
	M3i.xxxx-1GS	Memory upgrade to 1 GSample (2 GB) total memory		
	M3i.xxxx-2GS	Memory upgrade to 2 GSample (4 GB) total memory		
<b>Options</b>	Order no.	Option		
	M3i.xxxx-mr	Option Multiple Recording		
	M3i.xxxx-mt	Option pack including Multiple Recording, Timestamp		
	M3i.xxxx-mtab	Option pack including Multiple Recording, Timestamp, ABA mode		
	M3i.xxxx-SH4	Synchronization Star-Hub for up to 4 cards, only 1 slot width		
	M3i.xxxx-SH8	Synchronization Star-Hub for up to 8 cards, 2 slots width		
	M3i.xxxx-bxio	Option BaseXIO: 8 digital I/O lines usable as asynchronous I/O and timestamp ref-clock, additional bracket with 8 SMB connectors		
	M3i-upgrade	Upgrade for M3i.xxxx: later installation of option -bxio		
<b>Cables</b>	Order no.	Option		
	Cab-1m-9m-80	Adapter cable MMCX male to BNC male, 80 cm (for all other signals)		
	Cab-1m-9f-80	Adapter cable MMCX male to BNC female, 80 cm (for all other signals)		
	Cab-1m-9m-200	Adapter cable MMCX male to BNC male, 200 cm (for all other signals)		
	Cab-1m-9f-200	Adapter cable MMCX male to BNC female, 200 cm (for all other signals)		
	Cab-1m-9f-5	Adapter cable MMCX male to BNC female, 5 cm (short cable especially for oscilloscope probes)		
	Cab-3f-9m-80	Adapter cable SMB female to BNC male, 80 cm (for analog inputs)		
	Cab-3f-9f-80	Adapter cable SMB female to BNC female, 80 cm (for analog inputs)		
	Cab-3f-3f-80	Adapter cable SMB female to SMB female, 80 cm (for analog inputs)		
	Cab-3f-9m-200	Adapter cable SMB female to BNC male, 200 cm (for analog inputs)		
	Cab-3f-9f-200	Adapter cable SMB female to BNC female, 200 cm (for analog inputs)		
	Cab-3f-3f-200	Adapter cable SMB female to SMB female, 200 cm (for analog inputs)		
	Cab-3f-9f-5	Adapter cable SMB female to BNC female, 5 cm (short cable especially for oscilloscope probes)		
<b>Drivers</b>	Order no.	Option		
	M3i.xxxx-ml	MATLAB driver for all M3i cards		
	M3i.41xx-lv	LabVIEW driver for all M3i.41xx cards		
	M3i.41xx-vee	Agilent VEE driver for all M3i.41xx cards		

**Technical changes and printing errors possible**